

REV	DESCRIPTION	DATE
C	Initial Release	05.1026

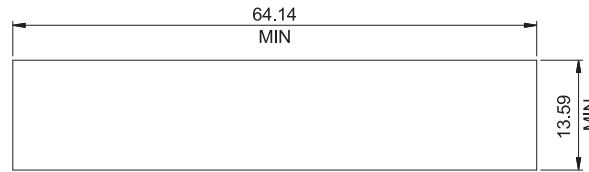

RECOMMENDED PANEL CUTOUT

**MATERIALS:**  
 PLASTIC HOUSING: ENGINEERING THERMOPLASTIC  
 FLAMMABILITY RATING UL 94V-0.  
 CONTACTS: PHOSPHOR BRONZE  
 PLATING: GOLD PLATING OVER NICKEL IN CONTACT,  
 TIN PLATING OVER NICKEL IN SOLDER AREA.  
 SHIELD: BRASS PLATING NICKEL ALLOY.

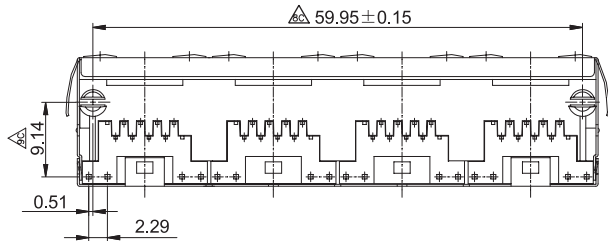
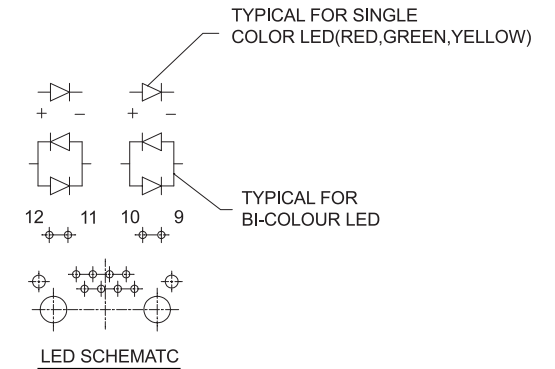
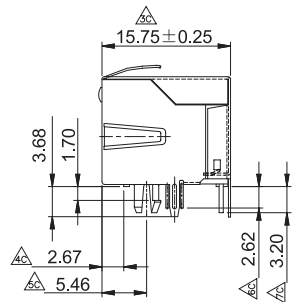
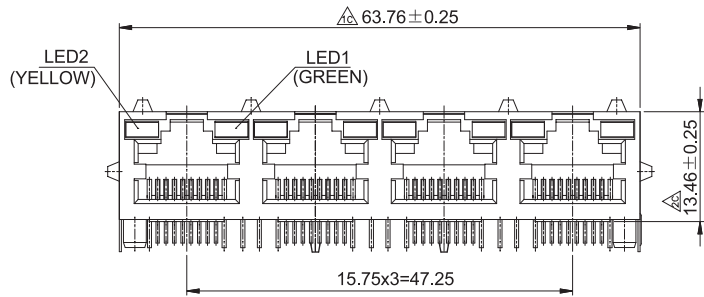
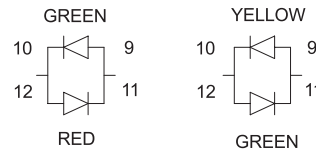

BI-COLOUR LED DETAIL  
 GREEN/RED AND YELLOW/GREEN  
 LED'S ARE ALSO AVAILABLE

PART NO : MJSDGY01K\*\*-4T3

LED Color(1,2) | Gold plating on the contacts  
 G : Green | 03 : 3u" Gold  
 Y : Yellow | 50 : 50u" Gold  
 R : Red

※  $\triangle$  : Q.C. Dimensions

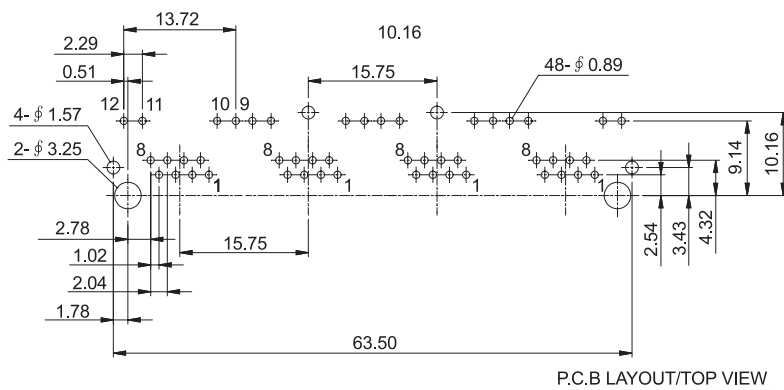

<b>PANSTRONG COMPANY LTD.</b>				DRAWN BY		<b>TOMMY</b>	
				CHECKED			
TITLE:		3046S 4PORT 8P8C JACK W/LED(Y-G)		APPROVED			
PART NO:		<b>MJSD-4 PORT (T3)</b>		DRAW NO			
DRAW. BOX NO:							
SCALE	2 : 1	REV	C	UNIT	mm		